

Petite

PE302

1 & 1/2 Bowl Sink With Drainer



All dimensions in mm

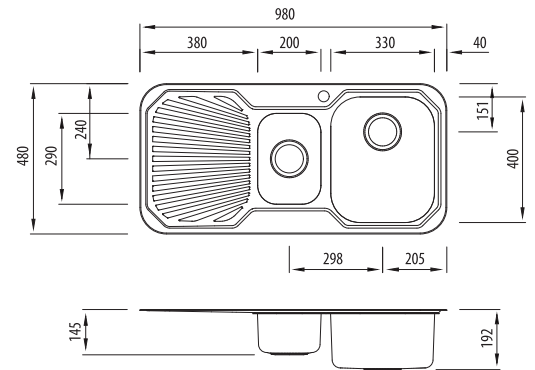

Specifications /

Sink size	980W x 480H mm
Bowl size	Main Bowl 330W x 400H x 180D / 21L 1/2 Bowl 200W x 290H x 130D / 7L
Construction	2 piece, bowls and drainer seam welded
Material	304 grade, 18/10 polished stainless steel (0.9 mm thick)
Installation	Topmount recommended
Fixings	Adjustable clips and sealing foam supplied
Min cabinet size	600 mm
Tap holes	Available 0 or 1 tap hole (specify when ordering)
Waste fittings	2 x 90 mm basket wastes included
Overflow	Not available
Carton size	990 x 490 x 200 mm
Weight	7 kg
Warranty	Lifetime manufacturer's warranty (refer to oliveri.com.au)
Maintenance and care instructions	All surfaces should be cleaned with mild liquid detergent or soap and water. To maintain the shine on your Oliveri stainless steel sink, we recommended the use of any of the easy to obtain, non-abrasive stainless steel cleaners or metal polishes.

Included accessories /

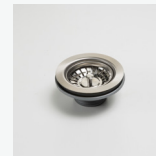

AC14
Basket Waste



AC14
Basket Waste



AC15
Bamboo Board



AC1820
Colander