

Nu-Petite

NP653

Double Bowl Topmount Sink With Double Drainer



All dimensions in mm

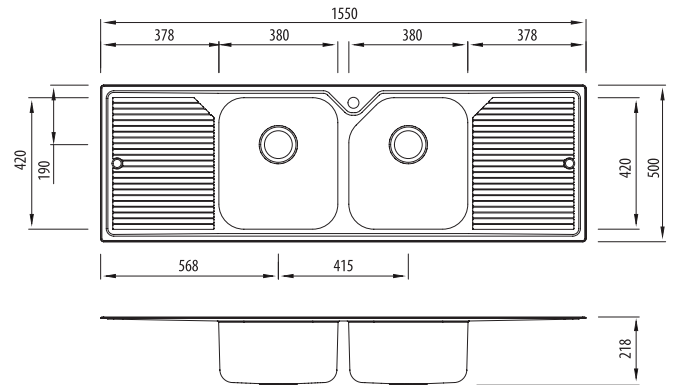

Specifications /

Sink size	1550W x 500H mm
Bowl size	Main Bowl 380W x 420H x 200D / 30L 5 Side Bowl 380W x 420H x 200D / 28L
Construction	2 piece, bowls and drainer seam welded
Material	304 grade, 18/10 polished stainless steel (0.9 mm thick)
Installation	Topmount
Fixings	Adjustable clips and sealing foam supplied
Min cabinet size	900 mm
Tap holes	1 tap hole only
Waste fittings	2 x 90 mm basket wastes included
Overflow	Not available
Carton size	1615 x 565 x 240 mm
Weight	14.5 kg
Warranty	Lifetime manufacturer's warranty (refer to oliveri.com.au)
Maintenance and care instructions	All surfaces should be cleaned with mild liquid detergent or soap and water. To maintain the shine on your Oliveri stainless steel sink, we recommended the use of any of the easy to obtain, non-abrasive stainless steel cleaners or metal polishes.

Included accessories /

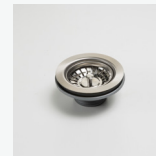

AC14
Basket Waste



AC14
Basket Waste



AC65
Bamboo Board



AC6220
Colander